

Data Sheet Wöhr Combilift 542-2,6

Suitable for condominium and office buildings.
For permanent use only!*

* In case of short time user (e.g. for offices, hotels, a.s.o.) technical adjustments are required. Please contact WÖHR!

Platforms are in horizontal position to drive on.

Load per platform max. 2600 kg
(load per wheel max. 650 kg)

X = to be clarified with door supplier.

Dimensions in cm

* in this zone, 0% of downward/upward slope in longitudinal and cross direction

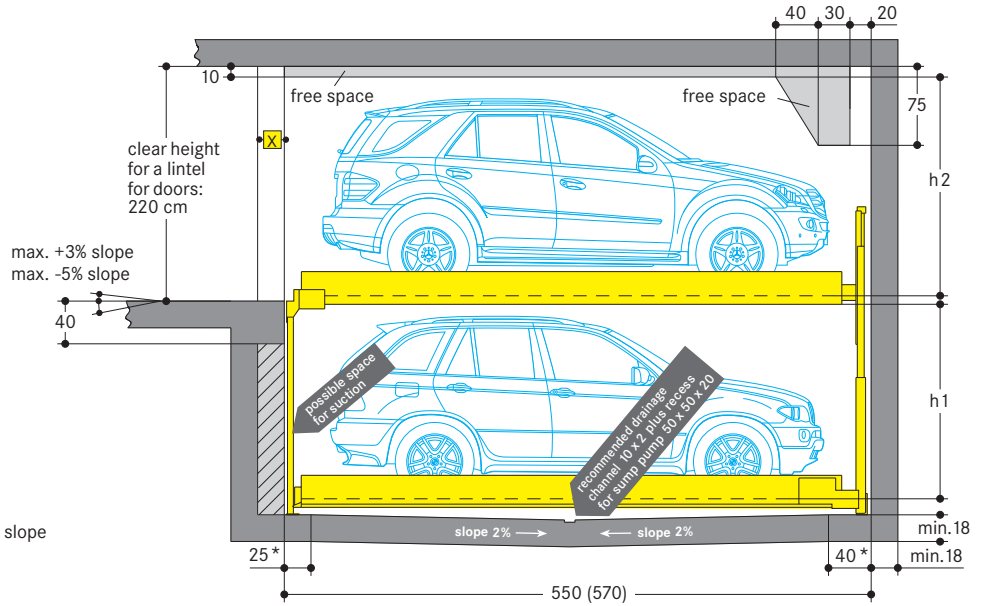

Standard type 542 · 2600 kg

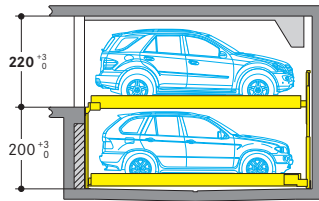

	car height	distance
EL*	Cars/Vans/SUV up to 200 cm	h2 = 205
LL*	Cars/Vans/SUV up to 175 cm	h1 = 180

Economic type 542 · 2600 kg

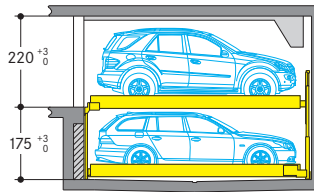

	car height	distance
EL	Cars/Vans/SUV up to 200 cm	h2 = 205
LL	Cars/Vans/SUV up to 150 cm	h1 = 155

Comfort type 542 · 2600 kg

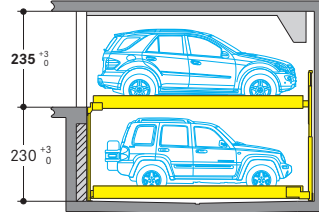

	car height	distance
EL	Cars/Vans/SUV up to 205 cm	h2 = 210
LL	Cars/Vans/SUV up to 205 cm	h1 = 210

* EL = entrance level, LL = lower level

Please attend to restricted car heights on lower platforms!

Width dimensions

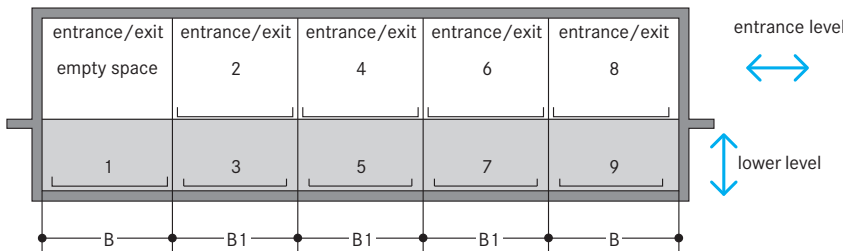

Space required	gives clear platform width
B B1	
280 270	250
290 280	260
300 290	270

One entry/exit is required on entrance level for each grid.

Notes

- Pits must always be protected by a sliding shutterdoor (even in underground garages).
- Arrangements start with 2 grids for 3 cars, 3 grids for 5 cars.
- Car length max. 500 cm with an installation length of 540 cm, car width 200 cm. In case of special platform widths narrower than 250 cm respectively, the maximum vehicle width is reduced accordingly.
- For very large cars an installation length of 570 cm is recommended. This length offers larger safety distances for potential future developments or projects with short term parkers such as hotels or similar.
- It is not possible to have channels or undercuts and/or concrete haunches along the pit floor-to-wall joints. In the event that channels or undercuts are necessary, the system width needs to be reduced or the pit needs to be wider.
- The manufacturer reserves the right to modify or alter above specifications.

Doors

According EN 14010, the Comblift 542 must be closed with shutterdoors. The door controls are integrated in the overall system. That means:

- The doors are electro-mechanically interlocked
- The doors can only be opened when the selected parking place has reached the entry/exit position
- Any pits are closed in the entrance area

Local requirements for electrical doors in respect to technology, maintenance, revision are not subject of our supply, which are according to European standard

Door types:

Manually operated sliding shutterdoors

- for underground garages in galvanised steel
- above ground with powder coated metal sheets (RAL 7030)

Alternatively, sliding shutterdoors may be supplied with electrical drive.

Installation:
Behind the building pillars
with door offset

Section

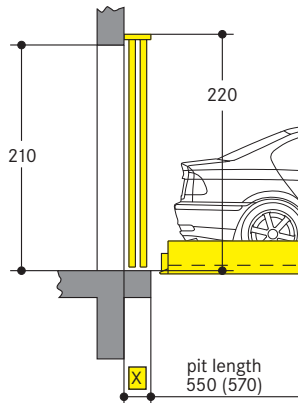

- X = 25 cm for manually operated sliding shutterdoors
- X = 35 cm for automatic shutterdoors

Ground plan

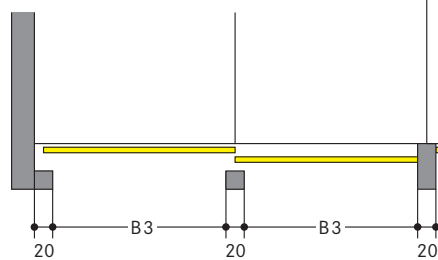

Installation:
Below the lintel between
the building pillars

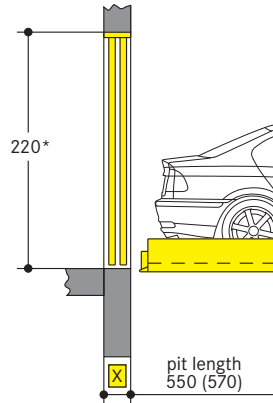

Installation:
In front of the
building pillars

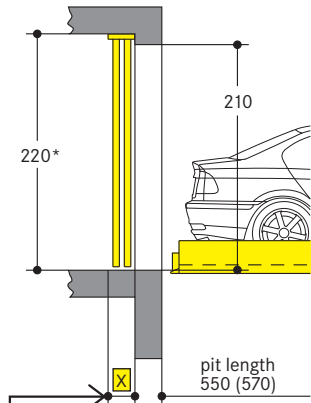

With installation in front of the pillars, the driving aisle is measured from the door.

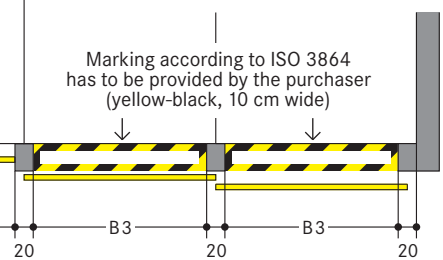

* The lintel of 220 cm is absolutely necessary. If differing heights additional fixings are required at additional charge. If no lintel is provided, the gates need to be fitted onto a steel frame (subject to surcharges).

Space required		Gives clear platform width
B3	B4	
250	520	250
260	540	260
270	560	270

Floor guide for sliding shutterdoors

Floor levelness in door guide range must be conformity with DIN 18202, table 3, line 3.

Hole depth for dowels approx. 8 cm.
Remark: When screed is applied in the door area to obtain floor levelness, the hole depth should be increased by screed thickness (max. 40 mm).

Finished floor acc. to DIN 18353
Floor levelness acc. to DIN 18202, table 3, line 3

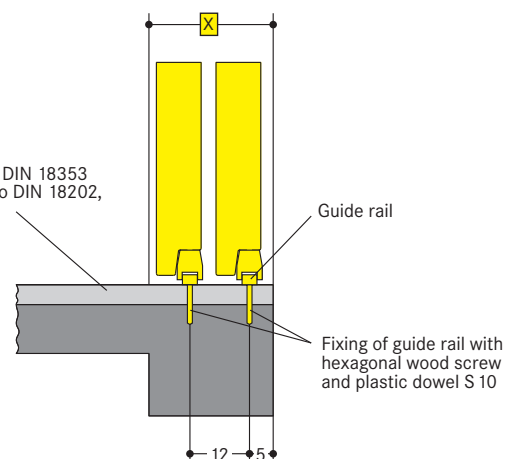

Width dimensions and statics

All dimensions shown are minimum. Constructional tolerances must be taken into consideration. All dimensions in cm.

Section

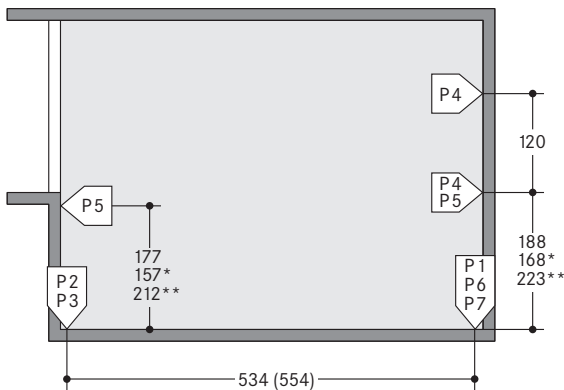

() dimensions in brackets for longer units

* dimensions for economic type

** dimensions for comfort type

P1 = +41,0 kN ¹⁾

P2 = +46,0 kN

P3 = +24,0 kN

P4 = ± 5,0 kN

P5 = ± 2,5 kN

P6 = ± 6,0 kN

P7 = ± 3,0 kN

¹⁾ all static loadings include the weight of the car

Bearing loads are transmitted by wall plates with min. 30 cm² surface and to the floor by base plates with min. 350 cm² surface.

Wall and base plates will be fixed by heavy duty anchor bolts to a drilling depth of 10-12cm. When fixing to the waterproof concrete floors chemical anchors are employed (to be advised by Wöhr).

Base plate thickness min. 18 cm. Rear wall and base plate must be formed of concrete and must have a flat surface without protrusions.

Concrete quality according to the static requirements of the building, but for the dowel fastening we require a concrete quality of min. C20/25.

The specified lengths to the support points are mean values. Please contact Wöhr Agent for exact positions for any variations on the standard units.

Please contact Wöhr Agent for clarify the door widths/widths of columns. Grid width of 270 /280/290 cm must be observed.

Ground plan

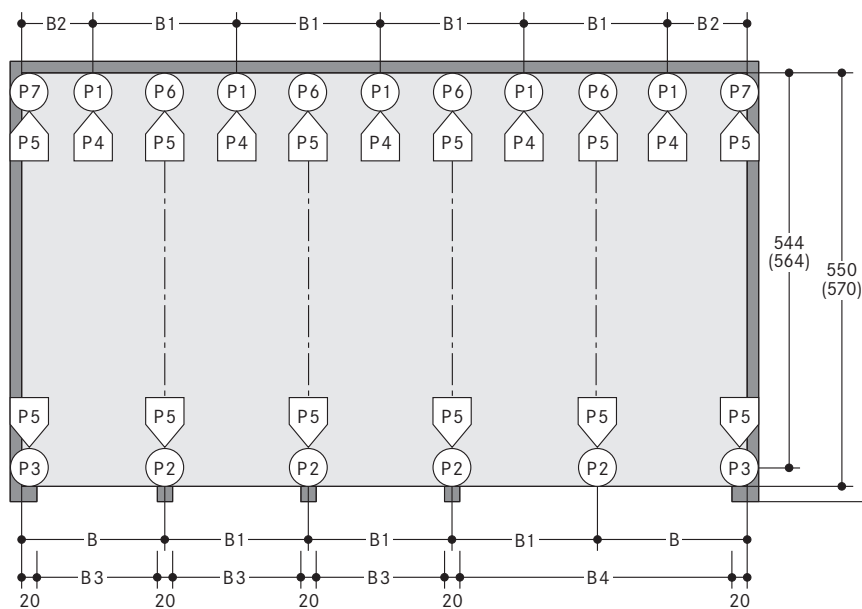

B	Space required				gives clear platform width
	B1	B2	B3	B4	
280	270	145	250	520	250
290	280	150	260	540	260
300	290	155	270	560	270

Minimum driveway width according to local requirements

Notice:

If the width of the pillars is more than 20 cm, than the width of the drive through will be reduced accordingly to the above mentioned width dimensions. In order to avoid this we recommend to extend the measures between the pillars (B3 and B4) accordingly. Please contact WÖHR.

Hydraulic power packs

For the accommodation of the hydraulic power packs an additional space is required which will be determined during the verifications of the drawings,

e.g. in a wall recess.
Dimensions:
length = 100 cm
height = 140 cm
depth = 35 cm

Electrical data

Main electrical supply 230/400V, 50 Hz, 3 phase. Power consumption 3.0 kW. Fuse or automatic circuitbreaker 3 x 16 A slow blow acc. to DIN VDE 0100 p. 430 and main supply line 5 x 2,5 mm² to the switch cabinet, provided by

client. In compliance with the DIN EN 60204 standard provisions, all systems must be connected directly on site with an earthed equipotential bonding. The lead-out connection must be at a 10 m distance!

Switch cabinet

1. Main switch is installed well accessible at driveway in a height of 160 cm to 190 cm.
2. The switch cabinet must be installed visible and near by the system. Area for installation has to be provided by the client. The size of the switch cabinet is 80 x 110 x 21 cm.
3. The wall opening of 15 cm diameter is required between the switch cabinet and the system itself. Please contact Wöhr Agent to clarify.
4. The control is designed to operate between +5° and +40°C. Atmospheric Humidity: 50% at +40°C. If the local circumstances differ from the above please contact Wöhr (if necessary, the switch cabinet has to be provided with a heating).
5. If the system is installed outside the switch cabinet needs to be inside a sun-/water-/wind proof box. In front of the switch cabinet an area of 100 cm is required to work.

General product information

The entrance level parking place row has one place less than the lower level. This empty space always stays on entrance floor level.
The platforms at the entrance floor level are shifted sideways by one

space so that the empty space is above the lower level platform to be raised.
This movement is initiated automatically when the desired place is selected via keyboard.

Hotel garage

If used by hotel guests, the installation requires special planning and construction. Please ask for details.

Noise protection

Basis is the German DIN 4109 "Noise protection in buildings".

With the following conditions required 30 dB (A) in rooms can be provided:

- noise protection package from our accessory
- insulation figure of the construction of min. $R'_W = 57$ dB
- walls which are bordering the parking systems must be done as single wall and deflection resistant with min. $m' = 300$ kg/m²
- solid ceiling above the parking systems with min. $m' = 400$ kg/m²

At differing constructional conditions additional sound absorbing measures are necessary.

The best results are reached by separated sole plates from the construction.

Increased noise protection:

If increased noise protection must be provided planning has to be confirmed on a project basis by Wöhr (further building measures are required).

Temperature

The installation is designed to operate between +5° and +40°C. Atmospheric Humidity: 50% at +40°C. If the local circumstances differ from the above please contact Wöhr.

Numbering of the parking spaces

1. The empty space of the Combilift is always on the left in the entrance level.
2. The numbering is as follows:

EG	2	4	6	8	
UG	1	3	5	7	9

3. The numbering for each system starts with 1 as above.
4. Different numbering of parking spaces is possible at extra cost (software changes are necessary).

Illumination

Illumination has to be considered acc. to local requirements by client.

Free spaces

Special drawings for free spaces to accommodate air ducts or other pipes can be requested at Wöhr Agent!

Railings

If walkways are arranged directly to the side or behind the systems, railings have to be provided by client acc. to local requirements, height min. 200 cm – this is applicable during the construction phase too.

Drainage

We recommend providing gutter in the pit centre and connecting the gutter either to a gully or a drainage pit 50 x 50 x 20 cm. If the pump sump is not accessible for manual drainage, the client must provide a pump on site to empty the pump sump. Lateral slope only within the gutter.

To prevent hazards for the ground water, we recommend giving the pit floor an oil-resistant coating as a means of protecting the environment.

If this is to be connected to the sewage system, it is advisable to provide oil and/or petrol separators.

Maintenance

Regular maintenance by qualified personnel can be provided by means of an Annual Service Contract.

Protection against corrosion

Independent of a maintenance workings has to be carried out acc. to Wöhr Cleaning and Maintenance Instruction regularly.

Clean up galvanized parts and platforms of dirt and road salt as well as other pollution (corrosion danger)!

Pit must be always ventilated and deaired well.

Dimensions

All dimensions shown are minimum. Construction tolerances must be taken into consideration. All dimensions in cm.

Clearance profile (standard saloon/estate car)

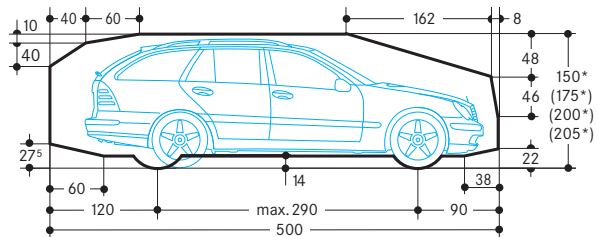

* The total car height includes roof rail and antenna fixture and must not exceed the mentioned max. height dimension.

Notes

We recommend providing wiring conduits leading to operating panels, particularly in above-ground garages.

The wiring conduits should be placed 120 cm above entrance level in a support in the middle of the area.